

Safety cartridge valves type JODL

2-way, poppet type, leak free, with optional inductive proximity sensor conforming to Machine Directive 2006/42/CE

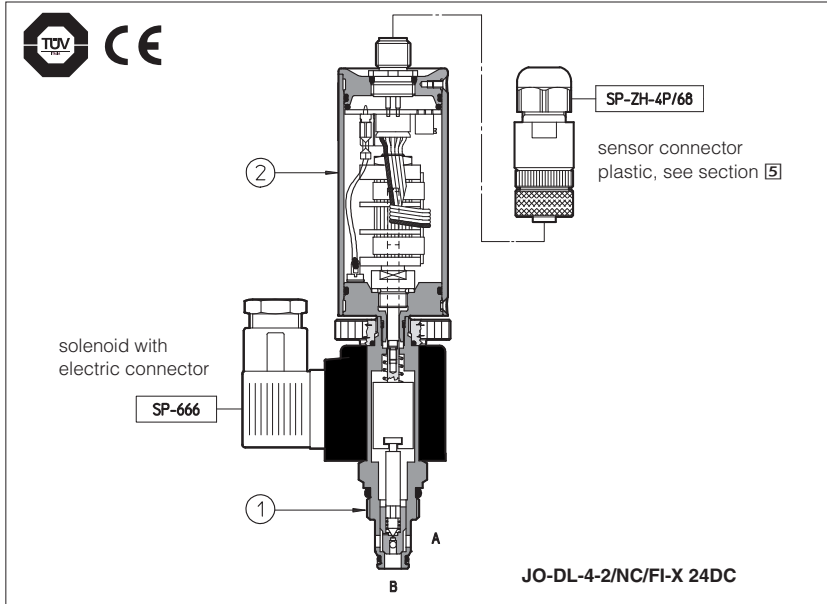

These screw-in solenoid cartridges are poppet type, leak free and are normally used to cut off the hydraulic power supply line. They are available in normally closed configuration NC, or normally open one NO.

The cartridges in /FI versions integrate an inductive sensor ② which supplies the output electrical on-off signal indicating the poppet ① position (open/closed), and therefore they can be used as safety valves for emergency conditions.

They are available only in NC configuration and are designed fulfil the safety criteria imposed by the European Machine Directive 2006/42/CE.

For details about the applicable EN standards, see www.atos.com, catalog on line page, section P, table P004.

Features:

- virtually zero internal leakage;
- limited pressure drops;
- low response times;
- great switching reliability even at high pressures and during long rests;
- CE marked and certified by TÜV for /FI version;

Cavity: ISO 17209;
Max flow: 150 l/min;
Max pressure: 350 bar.

1 MODEL CODE

JO	-	D	-	L	-	4	-	2	/	NC	/	FI	-	X	24DC	**
Cartridge valve screw-in type UNF																
D = Directional control																
L = Poppet type																
Size: 4 = 3/4"-16UNF-2B 6 = 7/8"-14UNF-2B 10 = 1 5/16"-12UNF-2B																
2 = Two-way																
Options (only for version NC): - = standard FI = inductive proximity sensor FI/T = with 5 poles connector for earth connection																
Versions: NC = normally closed NO = normally open																
X = Without connector see section 3 for available connector																
12DC = 12 Vdc 24DC = 24 Vdc																
Series number																

2 HYDRAULIC CHARACTERISTICS

Hydraulic symbols

/NO

/NC

/NC/FI

Model	JO-DL-4-2/NC	JO-DL-4-2/NO	JO-DL-6-2/NC	JO-DL-6-2/NO	JO-DL-10-2/NC	JO-DL-10-2/NO
Pressure limits [bar]	350					
Nominal flow [l/min]	40		75		150	
Response time: energizing [ms]	35	50	30	50	35	150
de-energizing [ms]	50	35	60	35	70	35
Internal leakage	less than 5 drops/min (≤ 0,36 cm ³ /min) max at 350 bar					

3 MAIN CHARACTERISTICS OF VALVES TYPE JODL

Installation position	Any position
Ambient temperature	From -20°C to + 70°C, from -20°C to +50°C for /FI versions
Fluid	Hydraulic oil as per DIN 51524 ... 535;
Recommended viscosity	10 ÷ 100 mm ² /s at 40°C (ISO VG 10 ÷ 100)
Fluid contamination class	ISO 19/16, achieved with in line filters at 25 µm and β ₂₅ ≥ 75 (recommended)
Fluid temperature	From -20°C to + 80°C
Flow direction	As shown in the symbols of table 2
Operating pressure	Ports A, B: 350 bar
Rated flow	See diagrams Q/Δp at section 7
Maximum flow	40 l/min for JO-DL-4; 75 l/min for JO-DL-6, 150 l/min for JO-DL-10
Relative duty factor	100%
Supply voltage	See model code at section 11
Supply voltage tolerance	±10%
Max power	19 Watt
Power connector	SP-666 (plastic - black); 3 pins, cable clamp PG11, cable max ø 11 mm
Type of connector for /FI version	Type SP-ZH-4P-68 (plastic); 4 pins, cable clamp PG9, cable max ø 8 mm
Type of connector for /FI/T version	Type SP-ZH-5P (plastic); 5 pins, cable clamp PG9, cable max ø 8 mm
Connectors features	SP-666: DIN 43650 - ISO 4400; IP65 (DIN 40050); VDE 0110C
	SP-ZH-4P/68: M12 - IEC60947-5-2; IP65 (DIN 40050)
	SP-ZH-5P: M12 - IEC60947-5-2; IP67 (DIN 40050)

to be ordered separately

4 INSTALLATION NOTES

- 1) The assembling of cartridges inside manifolds must be done tightening the valve exagonal ring (for tightening torque, see section 8). Excessive values can cause anomalous deformation and poppet sticking.
For the /FI versions avoid to tighten through the proximity box.
- 2) The CE certification is valid only with shielded electric cables and connector. Consult also tab. P004.
These safety valves must be supplied only and always as one complete component, proximity sensor is factory adjusted.
The supply of subcomponents invalidates the certification.

5 TECHNICAL CHARACTERISTICS AND CONNECTING SCHEME OF INDUCTIVE PROXIMITY SENSOR - VERSION /FI

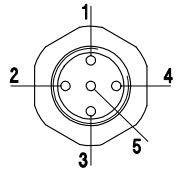
Supply voltage	[V]	18 ÷ 35	 <p>1 = Supply + 2 = Output signal NO 3 = Supply GND 4 = Output signal NC 5 = Earth (only option /T)</p>
Power consumption	[mA]	≤ 50 (without load)	
Output voltage	[V]	supply voltage -3,5 V	
Output current	[mA]	100 max (see note 1)	
Voltage drop	[V]	≤ 3,5 (with load 100 mA)	
Hysteresis	[mm]	< 0,02	
Thermal drift	[mm/K]	≤ 0,0015 (range: 0 ÷ 50 °C)	
Operating temperature	[°C]	-20 ÷ +50	
Electrical protection		against short circuit on the output signal	
Protection degree		IP67 DIN40050	
Maximum pressure	[bar]	350	
Sensor connector		Type SP-ZH-4P/68: standard M12, 4 poles; Type SP-ZH-5P: standard M12, 5 poles; max 20 m cable length	

(1) The output signal cannot be connected to loads requiring current > 100 mA

6 SIGNAL STATUS - VERSIONS /FI

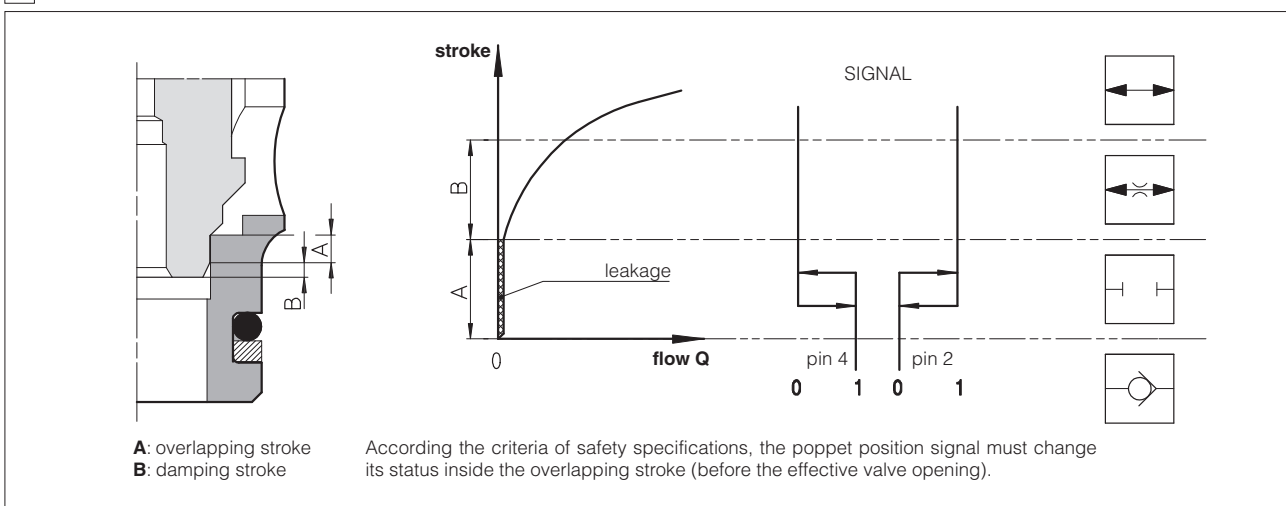

7.1 JO-DL-4

Valve pressure drop - NO version
1 = flow B → A
2 = flow A → B

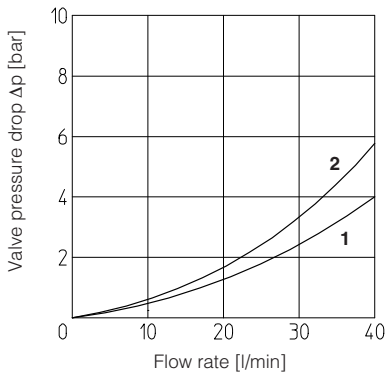

Valve pressure drop - NC version
3 = flow B → A energized
4 = flow A → B
5 = flow B → A de-energized

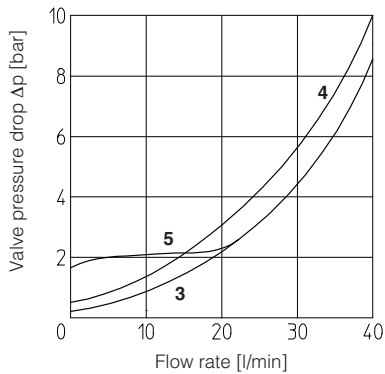

Valve pressure drop - NC/FI version
6 = flow B → A energized
7 = flow A → B
8 = flow B → A de-energized

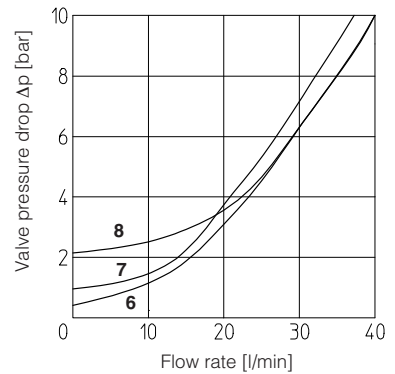

7.2 JO-DL-6

Valve pressure drop - NO version
1 = flow B → A
2 = flow A → B

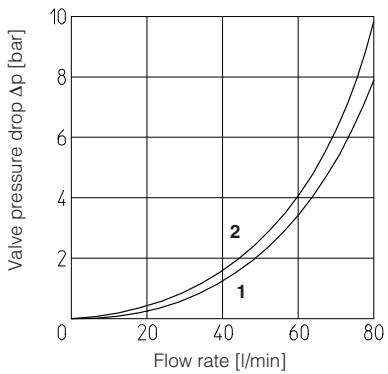

Valve pressure drop - NC version
3 = flow B → A energized
4 = flow A → B
5 = flow B → A de-energized

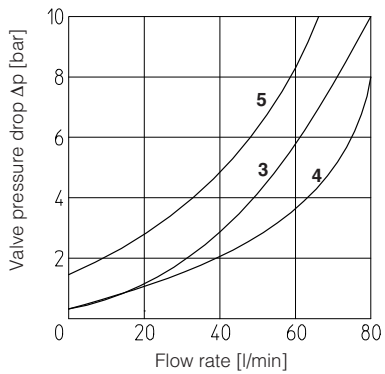

Valve pressure drop - NC/FI version
6 = flow B → A energized
7 = flow A → B
8 = flow B → A de-energized

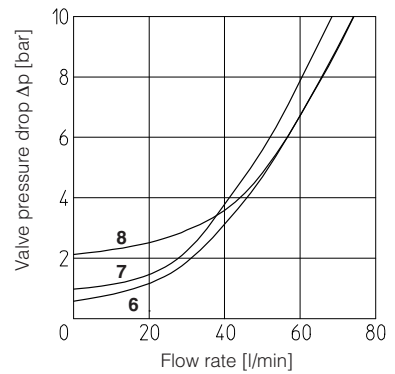

7.3 JO-DL-10

Valve pressure drop - NO version
1 = flow B → A
2 = flow A → B

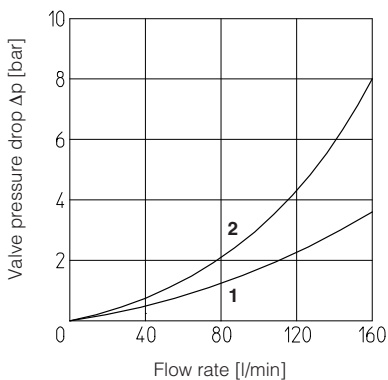

Valve pressure drop - NC version
3 = flow B → A energized
4 = flow A → B
5 = flow B → A de-energized

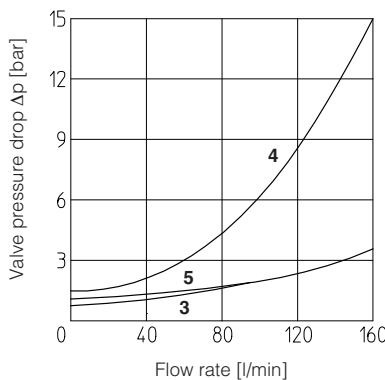

Valve pressure drop - NC/FI version
6 = flow B → A energized
7 = flow A → B
8 = flow B → A de-energized

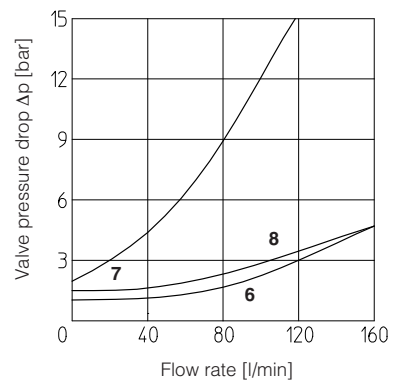

JO-DL-4

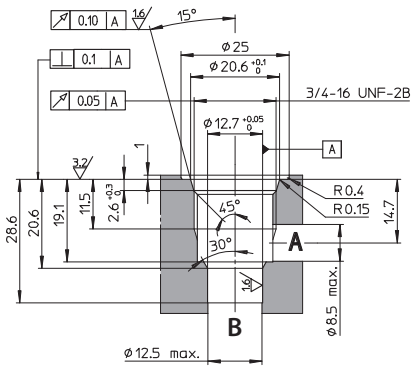

Version /NO

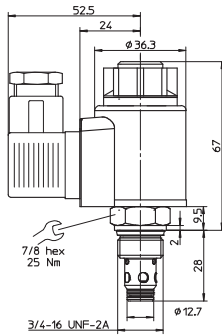

Version /NC

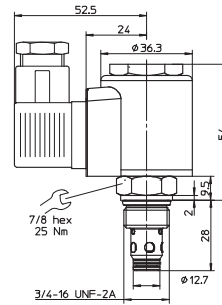

Version /NC/FI*

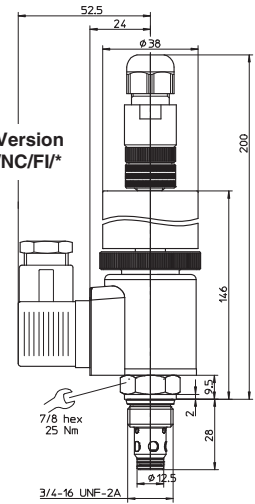

JO-DL-6

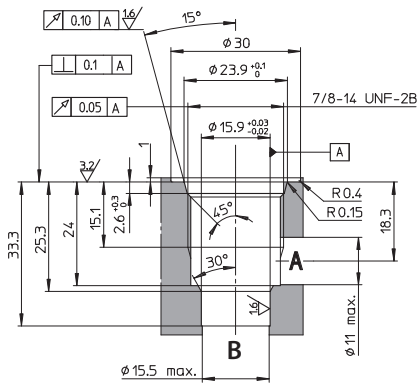

Version /NO

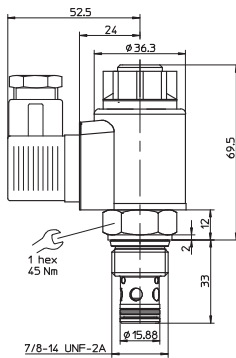

Version /NC

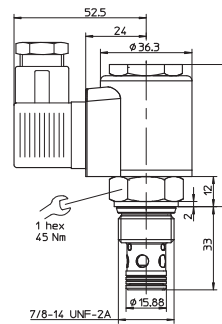

Version /NC/FI*

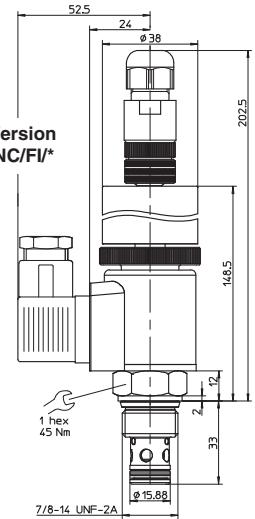

JO-DL-10

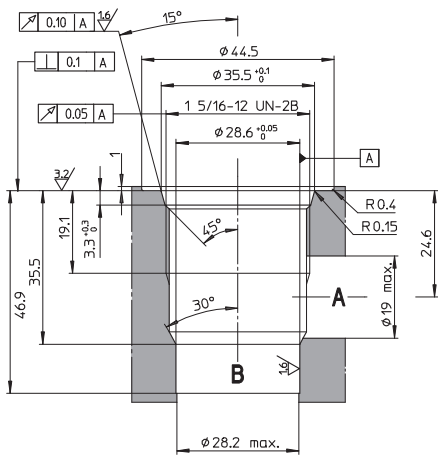

Version /NO

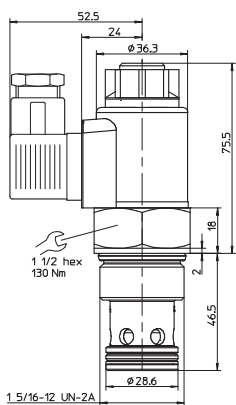

Version /NC

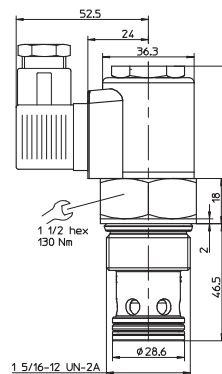

Version /NC/FI*

